

ABB standard drive

ACS550, 0.75 kW - 355 kW
Technical catalogue

Drive^{IT} Low Voltage AC Drive



Two ways to select your drive



Choice 1: Simply contact your local ABB drives sales office (see page 15) and let them know what you want. Use page 3 as a reference section for more information.

OR

Choice 2: Build up your own ordering code using the simple 7-step approach below. Each step is accompanied by a reference to a page that is filled with useful information.

Type code:

ACS550 - 01 - 03A3 - 4 + B055

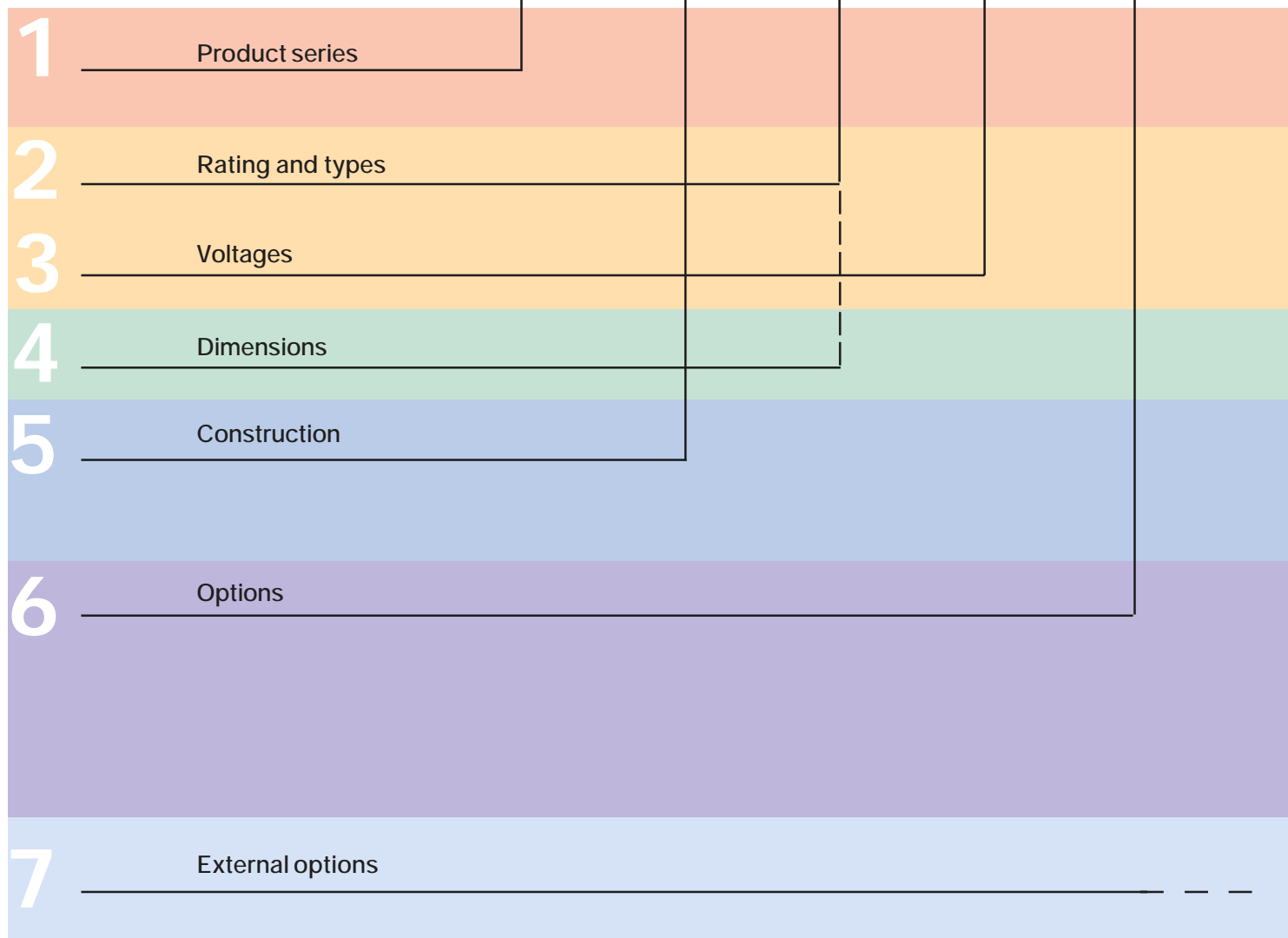



Contents

ABB standard drive, ACS550

	Page	
ABB standard drive	4	1
Ratings, types and voltages	5	2
		3
Dimensions	6	4
Construction	6	5
Assistant control panel	7	
Options	7	6
Control interfaces		
How to select options	7	
Basic control panel	7	
Plug-in options		
Extended relay output option module	8	
Plug-in fieldbus module	8	
External options		
DriveWindow Light 2	9	7
Output chokes	9	
Brake units and choppers	10	
Technical data	10	
Cooling	10	
Cable and fuse connections	11	
Technical specification	12	
Control connections	13	
Service products	14	
Contact and web information	15	

ABB standard drive



ACS550 - 01 - 03A3 - 4 + B055

What is an ABB standard drive?

The ABB standard drive is simple to buy, install, configure and use, saving considerable time. It is widely available through ABB's distributors, hence the use of the term standard. The drive has common user and process interface with fieldbus, common software tools for sizing, commissioning, maintenance and common spare parts.

Where can it be used?

The ABB standard drive can be used in a wide range of industries. Typical applications include pump, fan and constant torque use, such as conveyors. The ABB standard drive is ideal in those situations where there is a need for simplicity to install, commission and use and where customizing or special product engineering is not required.

ABB standard drive promises

- Precise delivery
- Quick installation
- Rapid start-up
- Trouble-free use

Highlights

- Assistant control panel providing intuitive use of the drive
- Patent pending swinging choke for superior harmonic reduction
- Sensorless vector control
- Integral RFI filter for 1st and 2nd environment as standard
- Flexible fieldbus system with built-in Modbus and numerous internally mountable fieldbus adapters
- UL, cUL and CE approved

What are its main features?

Feature	Note	Benefit
Assistant control panel	Two soft-keys, function of which changes according to the state of the panel Built-in "Help" button Real-time clock, allows timed tracing of faults and setting of parameters to activate at various times of day Changed parameters menu	Easy commissioning Fast set-up Easier configuration Rapid fault diagnosis Quick access to recent parameter changes
Brake chopper	Built-in up to 11 kW	Reduced cost
Chokes	Swinging DC chokes - matches the right inductance to the right load, thereby suppressing and reducing harmonics	Reduces Total Harmonic Distortion (THD) emissions up to 25%
Connectivity	Simple to install: Easy connection of cables Easy connection to external fieldbus systems through multiple I/Os and plug-in options	Reduced installation time Secure cable connections
Diagnostic assistant	Activated when fault occurs	Quick fault diagnostics
EMC	1 st and 2 nd environment RFI filters as standard	No need for additional external filtering
Fieldbus	Built-in Modbus using RS 485 Optional plug-in fieldbus modules	Reduced cost
Intuitive features	Noise optimisation: Increases switching frequency of drive when drive temperature is reduced Controlled cooling fan: Drive is cooled only when necessary	Considerable motor noise reduction Reduces inverter noise and improves energy efficiency
Maintenance assistant	Monitors running hours or motor rotation	Takes care of preventative maintenance of drive, the motor or run application
Mounting template	Supplied separately with unit	Quick and easy to mark mounting screw holes on installation surface
Sensorless vector control	Improved motor control performance	Enables wider range of applications
Start-up assistant	Guides user through all essential settings without going to parameter list	Easy set-up of parameters

Ratings, types and voltages



ACS550 - 01 - 03A3 - 4 + B055

Type code

This is the unique reference number (shown above and in column 7, right) that clearly identifies your drive by power rating and frame size. Once you have selected the type code, the frame size (column 8) can be used to determine the drives dimensions, shown below.

Voltages

The ACS550 is available in two voltage ranges:

- 4 = 380 - 480V
- 2 = 208 - 240V

Insert either "4" or "2", depending on your chosen voltage, into the type code shown above.

3-phase supply voltage 380-480 V Wall mounted units

Ratings						Type code	Frame size
Normal use			Heavy-duty use				
P _N kW	P _N hp	I _{2N} A	P _{hd} kW	P _{hd} hp	I _{2hd} A		
1.1	1.5	3.3	0.75	1	2.4	ACS550-01-03A3-4	R1
1.5	2	4.1	1.1	1.5	3.3	ACS550-01-04A1-4	R1
2.2	3	5.4	1.5	2	4.1	ACS550-01-05A4-4	R1
3	3	6.9	2.2	3	5.4	ACS550-01-06A9-4	R1
4	5	8.8	3	3	6.9	ACS550-01-08A8-4	R1
5.5	7.5	11.9	4	5	8.8	ACS550-01-012A-4	R1
7.5	10	15.4	5.5	7.5	11.9	ACS550-01-015A-4	R2
11	15	23	7.5	10	15.4	ACS550-01-023A-4	R2
15	20	31	11	15	23	ACS550-01-031A-4	R3
18.5	25	38	15	20	31	ACS550-01-038A-4	R3
22	30	44	18.5	25	38	ACS550-01-044A-4	R4
30	40	59	22	30	44	ACS550-01-059A-4	R4
37	50	72	30	40	59	ACS550-01-072A-4	R4
45	75	96	37	60	77	ACS550-01-096A-4	R5
55	100	124	45	75	96	ACS550-01-124A-4	R6
75	125	157	55	100	124	ACS550-01-157A-4	R6
90	150	180	75	125	156	ACS550-01-180A-4	R6

Free standing units

110	150	196	90	125	162	ACS550-02-196A-4	R7
132	200	245	110	150	192	ACS550-02-245A-4	R7
160	200	289	132	200	224	ACS550-02-289A-4	R7
200	300	368	160	250	302	ACS550-02-368A-4	R8
250	400	486	200	350	414	ACS550-02-486A-4	R8
280	450	526	250	400	477	ACS550-02-526A-4	R8
315	500	602	280	450	515	ACS550-02-602A-4	R8
355	500	645	315	500	590	ACS550-02-645A-4	R8

3-phase supply voltage 208-240 V Wall mounted units

Ratings						Type code	Frame size
Normal use			Heavy-duty use				
P _N kW	P _N hp	I _{2N} A	P _{hd} kW	P _{hd} hp	I _{2hd} A		
1.1	1.0	4.6	0.75	0.8	3.5	ACS550-01-04A6-2	R1
1.5	1.5	6.6	1.1	1.0	4.6	ACS550-01-06A6-2	R1
2.2	2.0	7.5	1.5	1.5	6.6	ACS550-01-07A5-2	R1
3.0	3.0	11.8	2.2	2.0	7.5	ACS550-01-012A-2	R1
4.0	5.0	16.7	3.0	3.0	11.8	ACS550-01-017A-2	R1
5.5	7.5	24.2	4.0	5.0	16.7	ACS550-01-024A-2	R2
7.5	10.0	30.8	5.5	7.5	24.2	ACS550-01-031A-2	R2
11.0	15.0	46.2	7.5	10.0	30.8	ACS550-01-046A-2	R3
15.0	20.0	59.4	11.0	15.0	46.2	ACS550-01-059A-2	R3
18.5	25.0	74.8	15.0	20.0	59.4	ACS550-01-075A-2	R4
22.0	30.0	88.0	18.5	25.0	74.8	ACS550-01-088A-2	R4
30.0	40.0	114	22.0	30.0	88.0	ACS550-01-114A-2	R4
37.0	50.0	143	30.0	40	114	ACS550-01-143A-2	R6
45.0	60.0	178	37.0	50	150	ACS550-01-178A-2	R6
55.0	75.0	221	45.0	60	178	ACS550-01-221A-2	R6
75.0	100	248	55.0	75	192	ACS550-01-248A-2	R6

Normal use vs heavy-duty use. For the majority of pump, fan and conveyor applications, select "Normal use" figures. For high overload requirements, select "Heavy-duty use" figures. If in doubt contact your local ABB sales office or your drives distributor - see page 15.

P_N for kW = Typical motor power in 400 V at normal use
 P_N for hp = Typical motor power in 460 V at normal use
 P_{hd} for kW = Typical motor power in 400 V at heavy-duty use
 P_{hd} for hp = Typical motor power in 460 V at heavy-duty use

Dimensions



ACS550 - 01 - 03A3 - 4 + B055

Wall mounted units

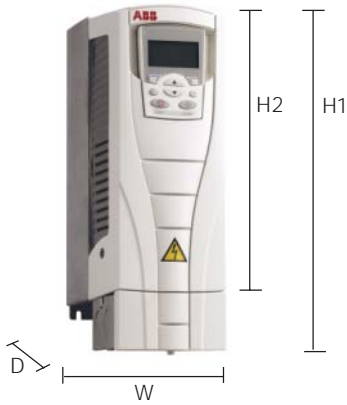

H1 = Height with cable connection box
 H2 = Height without cable connection box
 W = Width
 D = Depth

Free standing units

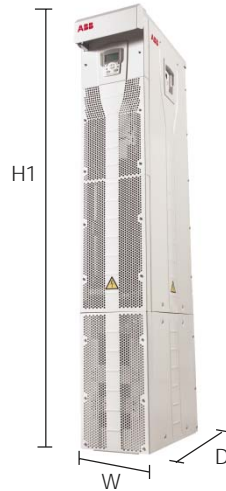

Wall mounted units

Frame size	Dimensions and weights								
	IP 21 / UL type 1					IP 54 / UL type 12			
	H1 mm	H2 mm	W mm	D mm	Weight kg	H mm	W mm	D mm	Weight kg
R1	369	330	125	212	6.5	441	215	238	8.4 ¹⁾
R2	469	430	125	222	9	541	215	245	11.5 ¹⁾
R3	583	490	203	231	16	604	257	276	18.1 ¹⁾
R4	689	596	203	262	24	723	257	306	26.6 ¹⁾
R5	739	602	265	286	34	776	369	309	42 ¹⁾
R6	880	700	300	400	69	924	410	423	86 ¹⁾

Free standing units

R7	1507	n/a	250 ²⁾	520 ²⁾	115
R8	2024	n/a	347 ²⁾	617 ²⁾	230

- ¹⁾ Preliminary
²⁾ The dimensions apply to bookshelf mounting. In flat type mounting the width and depth change places.
 n/a = not applicable

Construction

ACS550 - 01 - 03A3 - 4 + B055

“01” within the type code (shown above) varies depending on the drive mounting arrangement, and power rating. Choose the correct one for your needs from the table below:

01	02	for IP 54 units...
<ul style="list-style-type: none"> Wall mounted, frame size R1-R6 0.75 to 90 kW IP 21 Built-in EMC filter Standard software Built-in Modbus interface Cable connection box Brake chopper in frame sizes R1-R2 Assistant control panel 	<ul style="list-style-type: none"> Free standing, frame size R7-R8 90 to 355 kW IP 21 Built-in EMC filter Standard software Built-in Modbus interface Pedestal unit Assistant control panel 	<ul style="list-style-type: none"> If IP 54 is required, simply select “01” and then see page 7 to find the correct “Option” code. Free standing (02) units are not available in IP 54.

Assistant control panel



For easy drive programming, a detachable, multi-lingual alphanumeric assistant control panel is delivered as standard. The control panel has various assistants and a built-in help function to guide the user. It includes a real time clock, which can be used during fault logging and in controlling the drive, such as start/stop. The control panel can be used for copying parameters for back up or for downloading to another drive. A large graphical display and soft keys make it extremely easy to navigate.



Options

Control interfaces

ACS550 - 01 - 03A3 - 4 + B055

How to select options

The options shown below are available within the ACS550 range. Each has an associated 4-figure option code, which is shown in the table. It is this code that replaces B055 in the type code above. You can order as many options as required, simply by extending the code as necessary.

Available options

Protection class		
B055	IP 54	
Control panel		
OJ400	If no control panel is required	
J404	Basic control panel	ACS-CP-C
I/O options¹⁾		
L511	Relay output extension	OREL-01
Fieldbus²⁾		
K451	DeviceNet	RDNA-01
K452	LonWorks	RLON-01
K454	Profibus-DP	RPBA-01
K457	CANOpen	RCAN-01
K462	ControlNet	RCNA-01

¹⁾ One slot available for relay

²⁾ One slot available for fieldbus adapter. Modbus built-in as standard.

Basic control panel

The basic control panel features a single line numeric display. The panel can be used to control the drive, set the parameter values or copy them from one drive to another.

Options

Plug-in options

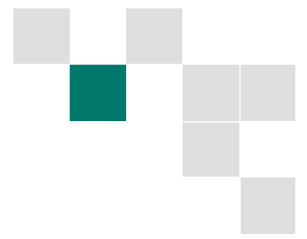

ACS550 - 01 - 03A3 - 4 + B055

Relay output extension option module

This plug-in option offers three additional relay outputs. They can be used, for example, in pump and fan control or many supervisory functions. All the relays can be programmed to on/off by using the assistant control panel's clock. Alternatively, fieldbus can be used to control any external components in the system.

Plug-in fieldbus module

The plug-in fieldbus options bring connectivity to major automation systems. A single twisted pair avoids large amounts of conventional cabling, thereby reducing cost and increasing system reliability.

The ACS550 supports the following fieldbus options:

- DeviceNet
- LonWorks
- Profibus-DP
- CANOpen
- ControlNet

For type codes see page 7

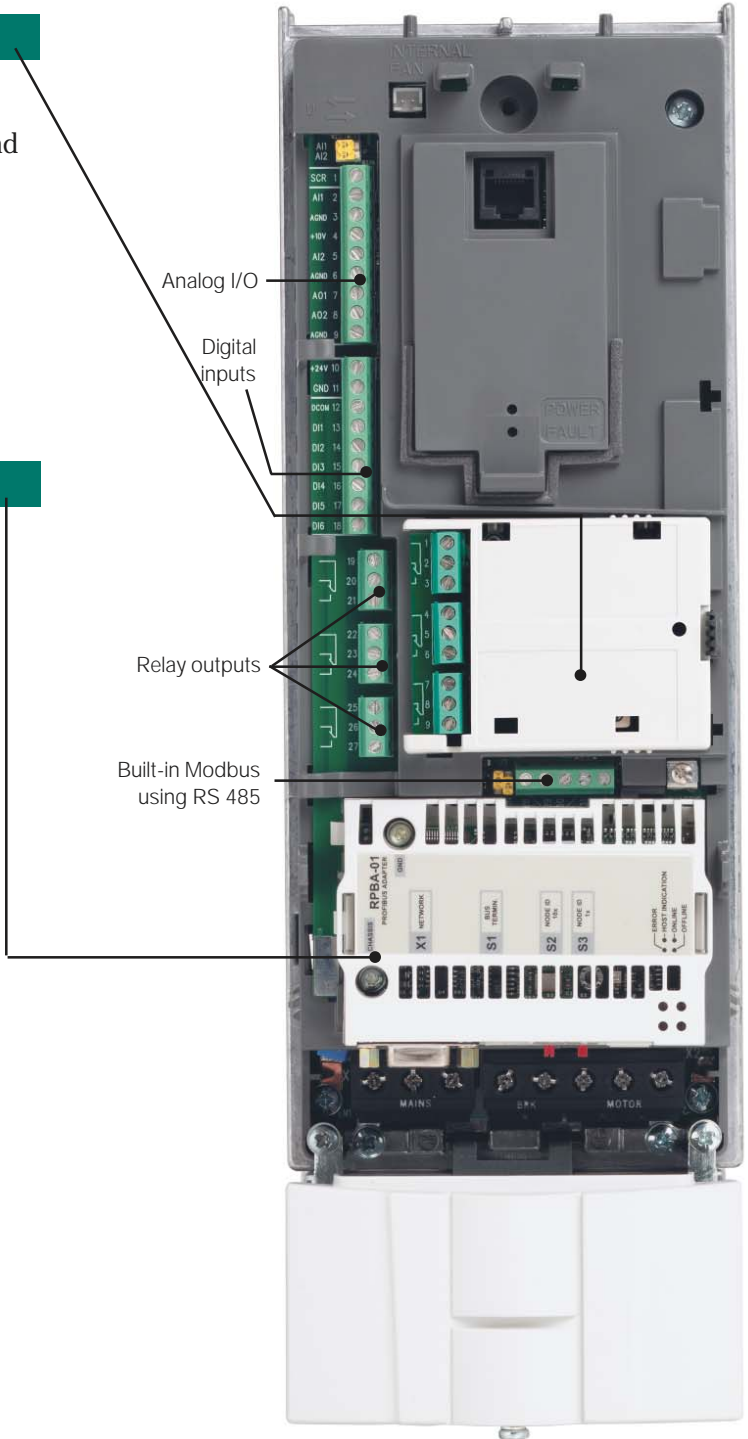

Options

External options

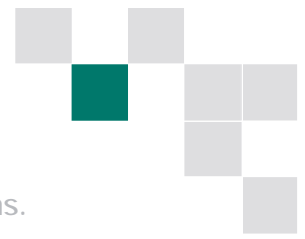

A separate order line and type code is required for any of these external options. These numbers are shown in the last column of the respective tables.

DriveWindow Light 2

DriveWindow Light 2 is PC software used for rapid commissioning and controlling of drives. It has features for programming, monitoring, trouble shooting and maintenance. It is also a set-up and control tool which is Win98, WinNT, Win2000 and WinXP compatible.

DriveWindow Light 2 operates both off- and on-line. No additional PC hardware is required. It uses the PC's RS-232 port. It is compatible with drive types ACS140, ACS160, ACS400, ACS550, ACS600, ACS800 and DCS400.

DriveWindow Light 2 features

- Graphical start-up wizards
- Off- and on-line viewing and changing of drive parameters
- Backup and restore parameters. In a fault situation the parameters can be reloaded resulting in time savings.
- Graphical monitoring of actual signal values
- I/O mapping table
- Control of the drive

Output chokes

Output chokes are used when motor cables above normal length are required. Cable can be roughly 1.5 times standard cable length, see below. The maximum switching frequency with output chokes is 4 kHz.

Selection table

Type code	Max. cable mm ²	I A	Max. cable length with choke (m)	Max. cable length without choke (m)	Output choke type code
ACS550-01-03A3-4	10	15	150	100	NOCH-0016-6X
ACS550-01-04A1-4	10	15	150	100	NOCH-0016-6X
ACS550-01-05A4-4	10	15	150	100	NOCH-0016-6X
ACS550-01-06A9-4	10	15	150	100	NOCH-0016-6X
ACS550-01-08A8-4	10	15	150	100	NOCH-0016-6X
ACS550-01-012A-4	10	15	150	100	NOCH-0016-6X
ACS550-01-015A-4	10	15	250	200	NOCH-0016-6X
ACS550-01-023A-4	10	15	250	200	NOCH-0016-6X
ACS550-01-031A-4	16	28	250	200	NOCH-0030-6X
ACS550-01-038A-4	16	28	250	200	NOCH-0030-6X
ACS550-01-044A-4	35	65	300	200	NOCH-0070-6X
ACS550-01-059A-4	35	65	300	200	NOCH-0070-6X
ACS550-01-072A-4	35	65	300	200	NOCH-0070-6X

X stands for degree of protection where 2 = IP 22 and 5 = IP 54

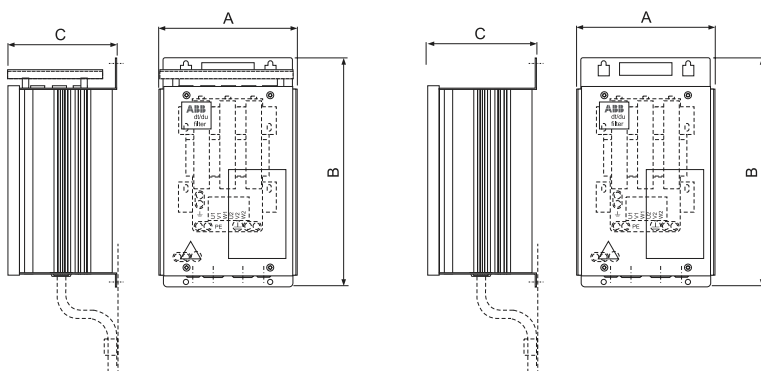

Dimensions

Output choke type code	A mm	B mm	C mm	Weight kg
NOCH-0016-62/65	199	323	154	6
NOCH-0030-62/65	249	348	172	9
NOCH-0070-62/65	279	433	202	15.5

Note

An output choke does not improve the EMC performance of the drive. To fulfil local EMC requirements use sufficient RFI filtering. For more information refer to the ACS550 Technical Reference Manual.

Options

External options



Brake units and choppers

Frame sizes R1 to R2 are delivered with integrated brake choppers as standard. Other units can use the compact-sized brake units which include brake chopper and resistor. For more information please refer to the ACS-BRK Brake Units Installation and Start-up Guide.

Brake units technical data

Frequency converter input voltage	Resistor ohm	Continuous output W	Max. output 20 s W	Brake unit type code
200 - 240 V AC 380 - 480 V AC	32	2000	4500 12000	ACS-BRK-C
200 - 240 V AC 380 - 480 V AC	10.5	7000	14000 42000	ACS-BRK-D

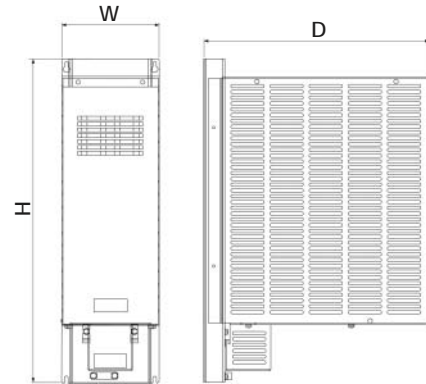

Dimensions

Width (W) mm	Height (H) mm	Depth (D) mm	Weight kg	Brake unit type code
150	500	347	7.5	ACS-BRK-C
270	600	450	20.5	ACS-BRK-D

Technical data

Cooling

ACS550 is fitted with cooling air fans. The cooling air must be free from corrosive materials and not above the maximum ambient temperature of 40°C (50°C with derating). For more specific environmental limits see page 12.

Cooling air flow 380 - 480 V units

Type code	Frame size	Heat dissipation		Air flow	
		W	BTU/Hr	m³/h	ft³/min
ACS550-01-03A3-4	R1	40	137	44	26
ACS550-01-04A1-4	R1	52	178	44	26
ACS550-01-05A4-4	R1	73	249	44	26
ACS550-01-06A9-4	R1	97	331	44	26
ACS550-01-08A8-4	R1	127	434	44	26
ACS550-01-012A-4	R1	172	587	44	26
ACS550-01-015A-4	R2	232	792	88	52
ACS550-01-023A-4	R2	337	1151	88	52
ACS550-01-031A-4	R3	457	1561	134	79
ACS550-01-038A-4	R3	562	1919	134	79
ACS550-01-044A-4	R4	667	2278	280	165
ACS550-01-059A-4	R4	907	3098	280	165
ACS550-01-072A-4	R4	1120	3825	280	165
ACS550-01-096A-4	R5	1440	4918	168	99
ACS550-01-124A-4	R6	1940	6625	405	238
ACS550-01-157A-4	R6	2310	7889	405	238
ACS550-01-180A-4	R6	2810	9597	405	238
ACS550-02-196A-4	R7	3050	10416	540	318
ACS550-02-245A-4	R7	3850	13148	540	318
ACS550-02-289A-4	R7	4550	15539	540	318
ACS550-02-368A-4	R8	6850	23394	1220	718
ACS550-02-486A-4	R8	7850	26809	1220	718
ACS550-02-526A-4	R8	7600	25955	1220	718
ACS550-02-602A-4	R8	8100	27663	1220	718
ACS550-02-645A-4	R8	9100	31078	1220	718

Cooling air flow 208 - 240 V units

Type code	Frame size	Heat dissipation		Air flow	
		W	BTU/Hr	m³/h	ft³/min
ACS550-01-04A6-2	R1	55	189	44	26
ACS550-01-06A6-2	R1	73	249	44	26
ACS550-01-07A5-2	R1	81	276	44	26
ACS550-01-012A-2	R1	118	404	44	26
ACS550-01-017A-2	R1	161	551	44	26
ACS550-01-024A-2	R2	227	776	88	52
ACS550-01-031A-2	R2	285	973	88	52
ACS550-01-046A-2	R3	420	1434	134	79
ACS550-01-059A-2	R3	536	1829	134	79
ACS550-01-075A-2	R4	671	2290	280	165
ACS550-01-088A-2	R4	786	2685	280	165
ACS550-01-114A-2	R4	1014	3463	280	165
ACS550-01-143A-2	R6	1268	4331	405	238
ACS550-01-178A-2	R6	1575	5379	405	238
ACS550-01-221A-2	R6	1952	6666	405	238
ACS550-01-248A-2	R6	2189	7474	405	238

Free space requirements

Enclosure type	Space above mm	Space below mm	Space on left/right mm
Wall mounted	200	200	25/25
Free standing	200	0	0

Technical data

Cable and fuse connections



Standard fuses can be used with ABB standard drives.
For input cable and fuse connections see tables below.

Recommended input protection fuses for 380 - 480 V units

Type code	Frame size	IEC fuses		UL fuses	
		A	Fuse type ¹⁾	A	Fuse type
ACS550-01-03A3-4	R1	10	gG	10	UL Class T
ACS550-01-04A1-4	R1	10	gG	10	UL Class T
ACS550-01-05A4-4	R1	10	gG	10	UL Class T
ACS550-01-06A9-4	R1	10	gG	10	UL Class T
ACS550-01-08A8-4	R1	10	gG	15	UL Class T
ACS550-01-012A-4	R1	16	gG	15	UL Class T
ACS550-01-015A-4	R2	16	gG	20	UL Class T
ACS550-01-023A-4	R2	25	gG	30	UL Class T
ACS550-01-031A-4	R3	35	gG	40	UL Class T
ACS550-01-038A-4	R3	50	gG	50	UL Class T
ACS550-01-044A-4	R4	50	gG	60	UL Class T
ACS550-01-059A-4	R4	63	gG	80	UL Class T
ACS550-01-072A-4	R4	80	gG	90	UL Class T
ACS550-01-096A-4	R5	125	gG	125	UL Class T
ACS550-01-124A-4	R6	160	gG	175	UL Class T
ACS550-01-157A-4	R6	200	gG	200	UL Class T
ACS550-01-180A-4	R6	250	gG	250	UL Class T
ACS550-02-196A-4	R7	250	gG	²⁾	UL Class T
ACS550-02-245A-4	R7	250	gG	²⁾	UL Class T
ACS550-02-289A-4	R7	315	gG	²⁾	UL Class T
ACS550-02-368A-4	R8	400	gG	²⁾	UL Class T
ACS550-02-486A-4	R8	500	gG	²⁾	UL Class T
ACS550-02-526A-4	R8	630	gG	²⁾	UL Class T
ACS550-02-602A-4	R8	630	gG	²⁾	UL Class T
ACS550-02-645A-4	R8	800	gG	²⁾	UL Class T

¹⁾ According to IEC-60269 standard

²⁾ Available later

Recommended input protection fuses for 208 - 240 V units

Type code	Frame size	IEC fuses		UL fuses	
		A	Fuse type ¹⁾	A	Fuse type
ACS550-01-04A6-2	R1	10	gG	10	UL Class T
ACS550-01-06A6-2	R1	10	gG	10	UL Class T
ACS550-01-07A5-2	R1	10	gG	10	UL Class T
ACS550-01-012A-2	R1	16	gG	15	UL Class T
ACS550-01-017A-2	R1	25	gG	25	UL Class T
ACS550-01-024A-2	R2	25	gG	30	UL Class T
ACS550-01-031A-2	R2	40	gG	40	UL Class T
ACS550-01-046A-2	R3	63	gG	60	UL Class T
ACS550-01-059A-2	R3	63	gG	80	UL Class T
ACS550-01-075A-2	R4	80	gG	100	UL Class T
ACS550-01-088A-2	R4	100	gG	110	UL Class T
ACS550-01-114A-2	R4	125	gG	150	UL Class T
ACS550-01-143A-2	R6	200	gG	200	UL Class T
ACS550-01-178A-2	R6	250	gG	250	UL Class T
ACS550-01-221A-2	R6	315	gG	300	UL Class T
ACS550-01-248A-2	R6	315	gG	350	UL Class T

Technical specification



ACS550

01

03A3

4

B055

Mains connection

Voltage and power range	3-phase, 380 to 480 V, +10/-15%, 0.75 - 355 kW 3-phase, 200 to 240 V, +10/-15%, 0.75 - 75 kW Auto-identification of input line
Frequency	48 to 63 Hz
Power factor	0.98

Motor connection

Voltage	3-phase, from 0 to U_{SUPPLY}
Frequency	0 to 500 Hz
Continuous loading capability (constant torque at a max ambient temperature of 40°C)	Rated output current I_2
Overload capacity (at a max. ambient temperature of 40°C)	At normal use $1.1 \times I_{2N}$ for 1 minute every 10 minutes At heavy-duty use $1.5 \times I_{2hd}$ for 1 minute every 10 minutes Always $1.8 \times I_{2hd}$ for 2 seconds every 60 seconds
Switching frequency	
Standard	Default 4 kHz
Selectable	0.75 - 90 kW 1 kHz, 4 kHz, 8 kHz up to 355 kW 1 kHz, 4 kHz
Acceleration time	0.1 to 1800 s
Deceleration time	0.1 to 1800 s

Environmental limits

Ambient temperature	
-15 to 40°C	No frost allowed
40 to 50°C	f_{switch} 4 kHz, derating please contact supplier
Altitude	
Output current	Rated current available at 0 to 1000 m reduced by 1% per 100 m over 1000 m to 2000 m
Relative humidity	lower than 95% (without condensation)
Protection class	IP 21 or IP 54
Enclosure colour	NCS 1502-Y, RAL 9002, PMS 420 C
Contamination levels	IEC 721-3-3
Transportation	No conductive dust allowed Class 1C2 (chemical gases), Class 1S2 (solid particles)
Storage	Class 2C2 (chemical gases), Class 2S2 (solid particles)
Operation	Class 3C2 (chemical gases), Class 3S2 (solid particles)

Programmable control connections

Two analog inputs	
Voltage signal	0 (2) to 10 V, $R_{in} > 312 \text{ k}\Omega$ single-ended
Current signal	0 (4) to 20 mA, $R_{in} = 100 \Omega$ single-ended
Potentiometer reference value	10 V $\pm 2\%$ max. 10 mA, $R < 10 \text{ k}\Omega$
Maximum delay	12...32 ms
Resolution	0.1%
Accuracy	$\pm 1\%$
Two analog outputs	0 (4) to 20 mA, load $< 500 \Omega$
Auxiliary voltage	24 V DC $\pm 10\%$, max. 250 mA
Six digital inputs	12 V... 24 V DC with internal or external supply, PNP and NPN
Input impedance	2.4 k Ω
Maximum delay	5 ms ± 1 ms
Three relay outputs	
Maximum switching voltage	250 V AC/30 V DC
Maximum switching current	6 A/30 V DC; 1500 V A/230 V AC
Maximum continuous current	2 A rms
Serial communication	
RS 485	Modbus protocol

Protection limits

Overvoltage trip limits	
Running V DC	842 (corr. to 595 V input)
Start inhibit V DC	661 (corr. to 380 - 415 V input), 765 (corr. to 440 - 480 V input)
Undervoltage trip limits	
Running V DC	333 (corr. to 247 V input)
Start inhibit V DC	436 (corr. to 380 - 415 V input), 505 (corr. to 440 - 480 V input)

Product compliance

Low Voltage Directive 73/23/EEC with supplements
Machinery Directive 98/37/EC
EMC Directive 89/336/EEC with supplements
Quality assurance system ISO 9001 and Environmental system ISO 14001
CE, UL and cUL approvals

EMC (according to EN61800-3)

1st environment restricted distribution with 30 m cable as standard
2nd environment unrestricted distribution with 100 m cable as standard
For longer motor cable lengths, external EMC filters are available on request

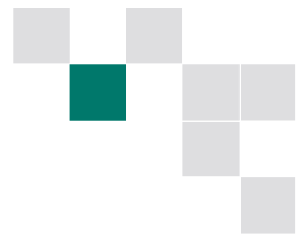

Control connections

ACS550 - 01 - 03A3 - 4 + B055

These connections are shown as examples only.
Please refer to the ACS550 User's Manual, chapter *Installations*, for more detailed information.

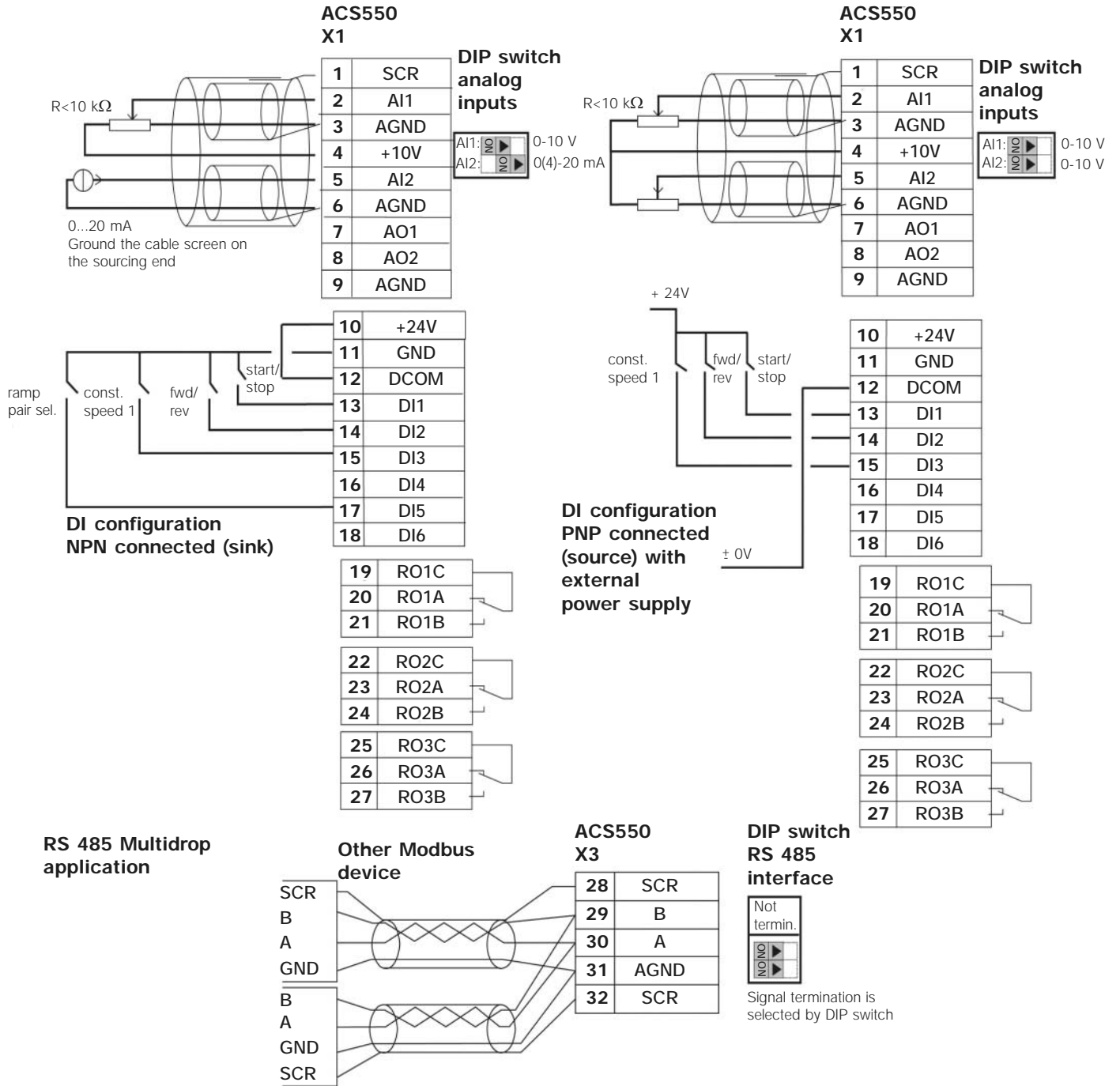

Service products



To reduce the total cost of owning ABB drives and to maximize their availability ABB offers the following services:

ABB maintenance services

ABB maintenance services ensure optimal operation of your drives and extends their useful life.

On-site spares kits

On-site spares kits contain the most critical spare parts for your AC drives. The contents of the kit can be chosen according to the number of drives in use. Having a spares kit on site reduces the downtime of equipment and increases the availability of critical processes.

Start-up services

Using ABB's start-up services you can trust that your drives are correctly commissioned and well-tuned to their application. ABB employs authorized professionals who have been thoroughly trained for their job.

Start-up services

Service product code	Service type	Description
START-UP 550	ACS550 - distance1	Professional start-up service
START-UP 550	ACS550 - distance2	Professional start-up service

Training services

ABB offers dedicated training on ABB drives for your service and operating personnel. Upon successful completion of the training course your personnel will have acquired the skills to use ABB drives correctly and safely, and also to get the best results from their application. The training courses are broken down into modules that allow for customization of the contents depending on the objectives and skill levels of the participants.

Training services

Service product code	Service type	Description
G165e	ACS550, G165e	Internet-based training
G165	ACS550, G165	Startup & Maintenance Hands-on 1 day

ABB has a service organization that spans the globe. Contact your local ABB sales office for more information about our services.



Contact and web information

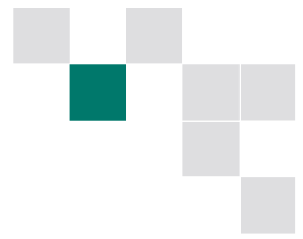

The ABB Group's philosophy "Think Global, Act Local" means that no matter where you are, or where you need a low voltage AC drive you can simply rely on ABB's worldwide network.

ABB's worldwide presence is built on strong local companies working together with the local distributor and channel partner network across borders to achieve a uniform level of services for all our customers. By combining the experience and know-how gained in local and global markets, we ensure that our customers in all

industries can gain the full benefit from our products.

For further details about all our variable speed drive products and services please contact your nearest ABB distributor or visit the ABB website www.abb.com/motors&drives.

For orders, quotations, etc. please contact your local ABB drives distributor, ABB office, or visit the website www.abb.com/drivespartners

Argentina (Valentin Alsina)
Tel: +54 (0)114 229 5707
Fax: +54 (0)114 229 5593

Australia (Victoria)
Tel: 1800 222 435
Tel: +61 3 8544 0000
Fax: +61 3 8544 0004

Austria (Vienna)
Tel: 0800 201 009
Tel: +43 1 60109-0
Fax: +43 1 60109-8312

Belarus (Minsk)
Tel: +375 172 236 711
Tel: +375 172 239 185
Fax: +375 172 239 154

Belgium (Zaventem)
Tel: +32 2 718 6313
Fax: +32 2 718 6664

Bolivia (La Paz)
Tel: +591 2 242 3636
Fax: +591 2 242 3698

Bosnia Herzegovina (Tuzla)
Tel: +387 35 255 097
Fax: +387 35 255 098

Brazil (Sao Paulo)
Tel: 0800 149 111
Tel: +55 11 3688 9282
Fax: +55 11 3684 1991

Bulgaria (Sofia)
Tel: +359 2 981 4533
Fax: +359 2 980 0846

Canada (Montreal)
Tel: +1 514 215 3006
Fax: +1 514 332 0609

Chile (Santiago)
Tel: +56 2 471 4391
Fax: +56 2 471 4399

China (Beijing)
Tel: +86 10 8456 6688
Fax: +86 10 8456 7636

Colombia (Bogota)
Tel: +57 1 417 8000
Fax: +57 1 413 4086

Croatia (Zagreb)
Tel: +385 1 238 3600
Fax: +385 1 239 5598

Czech Republic (Prague)
Tel: +420 234 322 360
Fax: +420 234 322 310

Denmark (Skovlunde)
Tel: +45 44 504 345
Fax: +45 44 504 365

Estonia (Tallinn)
Tel: +372 6 711 800
Fax: +372 6 711 810

Finland (Helsinki)
Tel: +358 10 22 11
Tel: +358 10 222 1999
Fax: +358 10 222 2913

France (Champagne)
Tel: +33 (0)810 020 000
Fax: +33 (0)472 054 041

Germany (Lampertheim)
Tel: +01805 123 580
Tel: +49 (0)6206 503 503
Fax: +49 (0)6206 503 600

Greece (Athens)
Tel: +30 210 289 1900
Fax: +30 210 289 1999

Hungary (Budapest)
Tel: +36 1 443 2224
Fax: +36 1 443 2144

India (Bangalore)
Tel: +91 80 837 0416
Fax: +91 80 839 9173

Indonesia (Jakarta)
Tel: +62 21 590 9955
Fax: +62 21 590 0115
Tel: +62 21 590 0116

Ireland (Dublin)
Tel: +353 1 405 7300
Fax: +353 1 405 7312

Israel (Tirat Carmel)
Tel: +972 4 858 1188
Fax: +972 4 858 1199

Italy (Milano)
Tel: +39 02 2414 3792
Fax: +39 02 2414 3979

Latvia (Riga)
Tel: +371 7 063 600
Fax: +371 7 063 601

Lithuania (Vilnius)
Tel: +370 5 273 8300
Fax: +370 5 273 8333

Luxembourg (Leudelange)
Tel: +352 493 116
Fax: +352 492 859

Macedonia (Skopje)
Tel: +389 2 118 010
Fax: +389 2 118 774

Malaysia (Kuala Lumpur)
Tel: +60 3 5628 4888
Fax: +60 3 5631 2926

Mexico (Mexico City)
Tel: +52 55 5328 1400
Fax: +52 55 5328 1482/1439

The Netherlands (Rotterdam)
Tel: +31 (0)10 407 8362
Fax: +31 (0)10 407 8433

New Zealand (Auckland)
Tel: +64 9 356 2170
Fax: +64 9 357 0019

Norway (Oslo)
Tel: +47 22 872 000
Fax: +47 22 872 541

Peru (Lima)
Tel: +51 1 561 0404
Fax: +51 1 561 3040

Philippines (Metro Manila)
Tel: +63 2 821 7777
Fax: +63 2 823 0309
Fax: +63 2 824 4637

Poland (Lodz)
Tel: +48 42 613 4900
Fax: +48 42 613 4901

Portugal (Amadora)
Tel: +351 21 425 6239
Fax: +351 21 425 6392

Romania (Bucarest)
Tel: +40 21 310 4377
Fax: +40 21 310 4383

Russia (Moscow)
Tel: +7 095 960 22 00
Fax: +7 095 913 96 95

Saudi-Arabia (Al Khobar)
Tel: +966 (0)3 882 9394
Fax: +966 (0)3 882 4603

Serbia and Montenegro (Belgrade)
Tel: +381 11 324 4341
Fax: +381 11 324 1623

Singapore
Tel: +65 6776 5711
Fax: +65 6778 0222

Slovakia (Banska Bystrica)
Tel: +421 48 410 2324
Fax: +421 48 410 2325

Slovenia (Ljubljana)
Tel: +386 1 587 5482
Fax: +386 1 587 5495

South Africa (Johannesburg)
Tel: +27 11 617 2000
Fax: +27 11 908 2061

South Korea (Seoul)
Tel: +82 2 528 2794
Fax: +82 2 528 2338

Spain (Barcelona)
Tel: +34 (9)3 728 8700
Fax: +34 (9)3 728 8743

Sweden (Västerås)
Tel: +46 (0)21 32 93 00
Fax: +46 (0)21 32 93 01

Switzerland (Zürich)
Tel: +41 (0)58 586 0000
Fax: +41 (0)58 586 0603

Taiwan (Taipei)
Tel: +886 2 2577 6090
Fax: +886 2 2577 9467
Fax: +866 2 2577 9434

Thailand (Bangkok)
Tel: +66 (0)2665 1000
Fax: +66 (0)2665 1042

Turkey (Istanbul)
Tel: +90 216 528 2200
Fax: +90 216 365 2944

United Kingdom (Manchester)
Tel: +44 (0)161 445 5555
Fax: +44 (0)161 445 6066

Uruguay (Montevideo)
Tel: +598 2 707 7300
Tel: +598 2 707 7466

USA (New Berlin)
Tel: +1 800 752 0696
Tel: +1 262 785 3200
Fax: +1 262 785 0397

Venezuela (Caracas)
Tel: +58 212 203 1817
Fax: +58 212 237 6270



ABB Oy

Drives

P. O. Box 184

FIN - 00381 Helsinki

Finland

Telephone +358 10 22 11

Fax +358 10 222 2764

Internet <http://www.abb.com/motors&drives>



441 024

Printed matter

HANSAPRINT/276411/2003

3AFE 64792857 REV D EN 5.12.2003 Specifications subject to change without notice.
The Industrial™ wordmark and all above-mentioned product names in the form Drive™ are registered or pending trademarks of ABB.

Ad agency PIRTEK#11034